

INSTRUCTION FLOW-METERS FOR LIQUIDS



REV. L, 2024-09-05

Note! More information about the product can be found in the data-sheet which is available for download from www.industrietechnik.it

Caution! Read and understand the instruction before using the product.

Caution! Ensure that the installation complies with local safety regulations.

Warning! Before installation or maintenance, the power supply must first be disconnected in order to prevent potentially lethal electric shocks! Installation or maintenance of this unit should only be carried out by qualified personnel. The manufacturer is not responsible for any eventual damage or injury caused by inadequate skills during installation, or through removal of or deactivation of any safety devices.

Function

Take into account that the arrow on the flow-meter indicates the flow direction. Incorrect installation can result in poor performance and/or reduced lifespan. The Industrietechnik flow meters is used to measure the flow rate of water in pipelines under declared medium conditions, and they are essential in a wide range of industries, including oil and gas, chemical plants, pharmaceuticals, food and beverage, and water treatment, in particular on heat pumps where it is useful or necessary to know with a good time response the amount of circulating flow. An electronic temperature sensor is available to monitor the temperature of the fluid. The electronic solution used allows a choice of various output signals or Modbus.

The absence of moving parts ensures stable operation over time and eliminates maintenance work.

Technical Data

Nominal diameter	DN20	DN25
Connection	G1 according to ISO 228 male	G1 1/4 according to ISO 228 male
Weight [g]	70	90
Flow rate [l/min]	5...80	10...150
Accuracy [Flow]	±1 %	±2 %
Repeatability [Flow]	±1 %	±1.5 %
Flow output	Modbus	
	0...10 Vdc (RL ≥ 10 kΩ)	
	0 V -> 0 l/min	0 V -> 0 l/min
	10 V -> 80 l/min	10 V -> 150 l/min
	4...20 mA (RL max ≤ 250 Ω)	
	4 mA -> 0 l/min	4 mA -> 0 l/min
Frequency NPN open collector	0 Hz -> 0 l/min	0 Hz -> 0 l/min
	1000 Hz -> 80 l/min	1000 Hz -> 150 l/min
Temperature output	Modbus	
	0...10 Vdc RL ≥ 10 kΩ	
Power supply	12...24 Vdc ±10%	
Consumption	< 1 VA	
Medium temperature range	-20...+90 °C	
Accuracy [Temp]	±0.8 K	
Pressure rating	PN10	
Medium	Water and aqueous solution (with usual additives)	
Medium Temperature range	-20...+90 °C	
Working ambient temperature	-20...+60 °C	
Storage Temperature	-20...+70 °C	
Protection	IP65	
Approval	CE, UKCA	
CE compliance standard	EN IEC 61326-2-3:2021	

Materials

Body	PA6 50% glass fibre reinforced
Material Cover	ETFE
O-ring	EPDM

Installation

The product is available in multiple sizes, which are easily installed with standard 1" and 1" 1/4 gas connection. The LED, visible on the electronic board, has three colours to simplify the installation and monitor the transducer reading/operation status.

LED color	Meaning (intermittent, on for 1 second every 5 seconds)
red	missing flow
yellow	flow rate out of range
green	flow rate in the range

Proper installation guidelines

Mounting this category of flow meters in inadequate systems can significantly compromise measurement performance. In order archive accurate and repeatable performance declared into the datasheet it is recommended to follow the succeeding points:

1. The installation position must prevent vibrations from being transmitted to the flow meter.
2. It is necessary to avoid as much as possible installing the device in points of the system that can apply mechanical stress to the flow meter.
3. The connection cable must not be longer than 3 m.

4. Avoid obstacles such as misalignments, protruding flat gaskets, diameter variations, etc. near the inlet and outlet of the flow meter. These can cause strong disturbances in the signal, resulting in false reading. At the meantime the connecting pipes must have the same diameter as the flow meter for a specific length of the inlet and the outlet of the body. This value is shown in the table below (DN = nominal diameter).

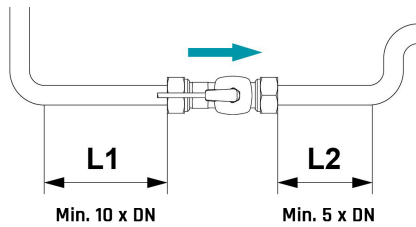

5. As shown in the images below, the flow meter can be mounted in all positions except for the case in which system filling problems may arise (See example at point 6).

Figure A: the device positioned vertically with the upstream flow, ensure the best possible measuring accuracy.

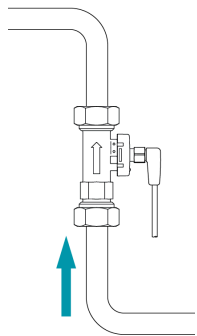
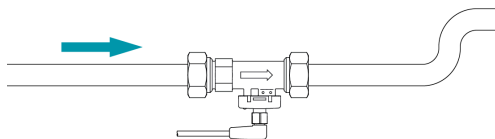

Figure B: the device can be positioned horizontally upsidedown.



6. In the images below, system filling problems may arise.

Figure C: downwards curved pipe can collect air-bubble in the proximity of the trasducers.

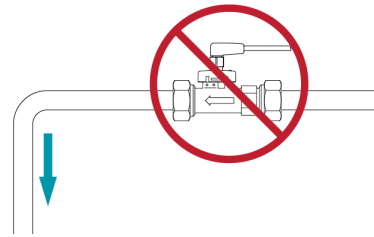

Figure D: straight downwards pipe can cause flow rate discontinuity.



7. Cavitation phenomena can drastically reduce the performance of the flow meter. To prevent this issue it is recommended to respect the indication about the minimum system pressure inside the pipe. In the following table indications of these values are reported, based on the device size.

Nominal diameters	DN20	DN25
Pressure (bar)	1,5	1,7

8. It is recommended to only use the O-ring provided, without that the connection may have leakage.

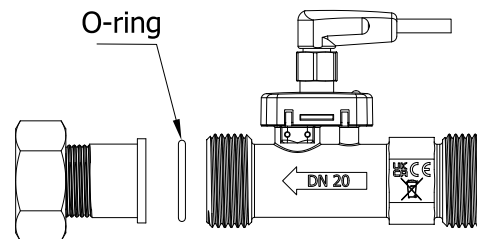

9. It is important to verify the maximum torque applied to the hexagon of the device because the plastic body of the flow meter can be damaged. In the following table is reported the recommended torque, referred to as the nominal diameter (DN).

Nominal diameter	Hexagon size [mm]	Torque (Nm)
DN20	27	16
DN25	34	22

Wiring

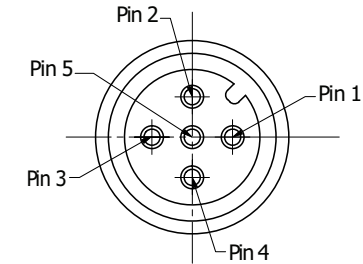

N pin	Version			Cable colours MFC5L2 (optional)
	0...10 V	4...20 mA	Modbus	
Pin 1	Vin	Vin	Vin	Brown
Pin 2	Out Flow (0...10 V)	Out Flow (4...20 mA)	Gnd	White
Pin 3	Gnd	Gnd	M+	Blue
Pin 4	Out Flow (Freq)	Out Flow (Freq)	M-	Black
Pin 5	Out Temp	-	Reset Par.	Grey

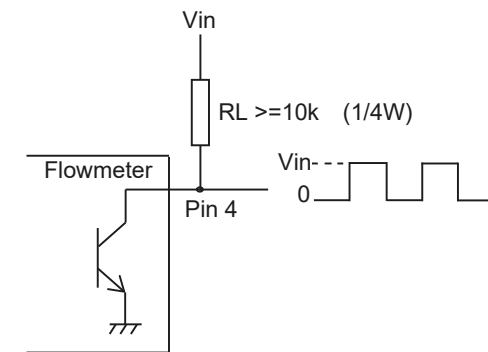

Notathe frequency output is a square wave with 50% duty oscillating between Vin (positive power supply) and ground. The frequency is available on Pin 4, an external resistor must be mounted between Pins 4 and 1 ($R_L \geq 10 \text{ k}\Omega$ \varnothing 1/4 W).

Only for Modbus versions: to reset the communication parameters, power the flowmeter and connect Pin 5 with Pin 2 for 1 second. The communication parameters are reset to the default values (address = 50, baud rate = 19200, parity = even, 1 stop bit).

Settings (only for Modbus versions)

Address	Description
3999	ADR_MOD_VAR -> baud rate Modbus communication 0 = 9600 1 = 19200 2 = 38400
4000	ADR_MOD_VAR_PARITY -> parity Modbus communication 0 = no parity 1 = odd 2 = even
4001	ADR_MOD_VAR_STOP_BIT -> stop bit Modbus communication 0 = 1 stop bit 1 = 2 stop bit
4002	ADR_MOD_VAR_ADDRESS -> address of unit in Modbus network
4003	ADR_MOD_VAR_FLOW -> flow value based on the unit set The flow value read in l/min or gpm is multiplied x10 Example: 534 corresponds to 53.4 per l/min or gpm (gallon/min) The flow value read in l/h remains unchanged Example: 534 corresponds to 534 per l/h
4004	ADR_MOD_VAR_FLOW_STATUS -> state of flow measurement 0 = flow not measurable 1 = flow in the range of measure (5...80 l/min for DN20, 10...150 l/min for DN25) 2 = flow out of range
4005	ADR_MOD_VAR_FLOW_UNIT -> unit of flow measurement 0 = l/min 1 = l/h 2 = gpm (gallon/min)
4006	ADR_MOD_VAR_FLOW_SPEED -> speed of the flow in the pipe m/s x 10
4007	ADR_MOD_VAR_TEMP_SENS -> value of temperature (x 10) with °C or (x 1) with °F In case of error the value of temperature is visualized as 99.9°C (or 212 °F) In case of absent sensor is visualized as 88.8°C (or 192 °F)
4008	ADR_MOD_VAR_TEMP_STATUS -> status of temperature sensor 0 = error 1 = no error 2 = temperature not present
4009	ADR_MOD_VAR_TEMP_UNIT 0 = °C (temp x 10) 1 = °F
4010	ADR_MOD_VAR_FIRMWARE_VERSION -> firmware version
4011	ADR_MOV_VAR_DN -> describes the product type 20 = DN20 25 = DN25

Address	Unit	Default	Min		Max		R/W
3999		1	0		2		R/W
4000		2	0		2		R/W
4001		0	0		1		R/W
4002		50	1		247		R/W
4003			DN20	DN25	DN20	DN25	R
	l/min (x 10)		50	100	800	1500	
	l/h		300	600	4008	9000	
	gpm		13	26	211	369	
4004			0		2		R
4005		0	0		2		R/W
4006	m/sec (x 10)		DN20	DN25	DN20	DN25	R
			3	4	47	55	
4007	°C (x 10)		-200		-200	900	R
	°F		-4		-4	194	
4008			0		2		R
4009		0	0		0		R/W
4010			0		59999		R
4011		20/25					R



This product carries the CE-mark. More information is available at www.industrietechnik.it.

Contact

AB Industrietechnik SRL, Via Julius-Durst-Str. 50, I-39042 Bressanone (BZ)
Tel: +39 0472 830626, Fax: +39 0472 831840
www.industrietechnik.it, info@industrietechnik.it