

REGIO RU-F



REGIO

Box 116, SE-428 22 Källered, Sweden
Tel: +46 31 720 02 00, Fax: +46 31 720 02 50
www.regin.se, info@regin.se

6651C
MAY 19



Ensure that the installation complies with local safety regulations. Information about commissioning of the product can be found in the manual "Regio Maxi Manual", which is available for download from www.regin.se.



Följ lokala säkerhetsföreskrifter vid installation av produkten. Information om idrifttagning av produkten finns i manualen "Regio Maxi Manual", som kan laddas ner från www.regin.se.



Veillez respecter les consignes de sécurité locales pendant l'installation du produit. Accéder à des renseignements quant à la mise en service du produit dans le manuel "Regio Maxi Manual", disponible pour téléchargement auprès du site www.regin.se.



Bei der Installation des Produkts sind die lokalen Sicherheitsvorschriften zu beachten. Informationen zur Inbetriebnahme des Produkts sind im Handbuch „Regio Maxi Manual“ zu finden, das bei www.regincontrols.de heruntergeladen werden kann.



RU-F är avsedd att användas tillsammans med Regio RCP100F, RCP100FT, RCP200F eller RCP200FT. Se även installationsanvisning för RCP...



RU-F is intended for use together with Regio RCP100F, RCP100FT, RCP200F or RCP200FT. See also the installation instruction for RCP...



RU-F doit être utilisé avec Regio RCP100F, RCP100FT, RCP200F ou RCP200FT. Voir aussi le manuel d'installation de RCP...



RU-F ist für den gemeinsamen Einsatz mit Regio RCP100F, RCP100FT, RCP200F oder RCP200FT vorgesehen. Siehe auch die Installationsanleitung zu RCP...

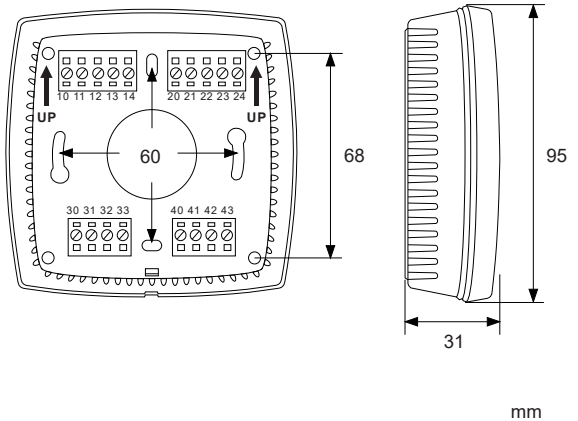

mm

1.

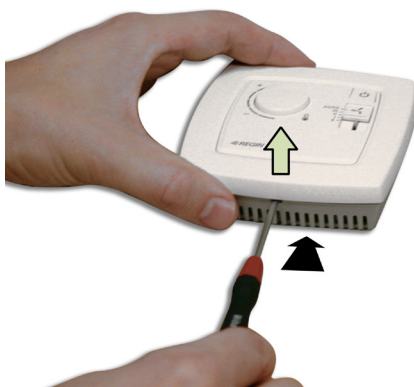

2.

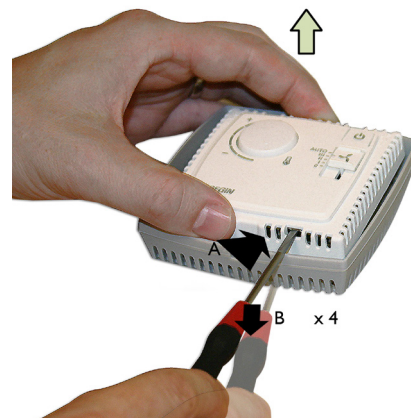

3.

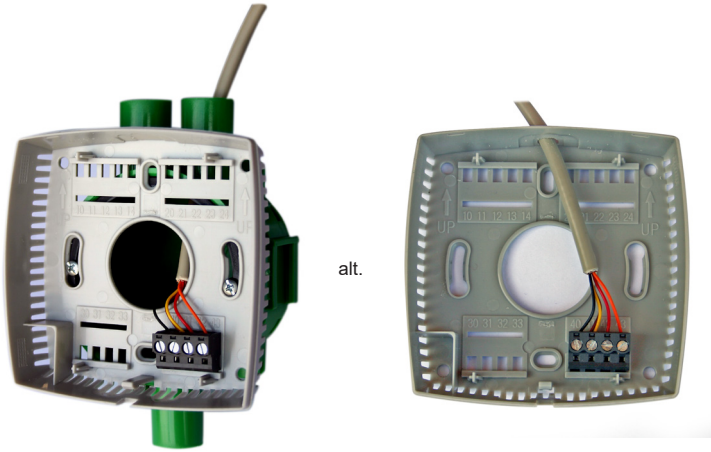

4.

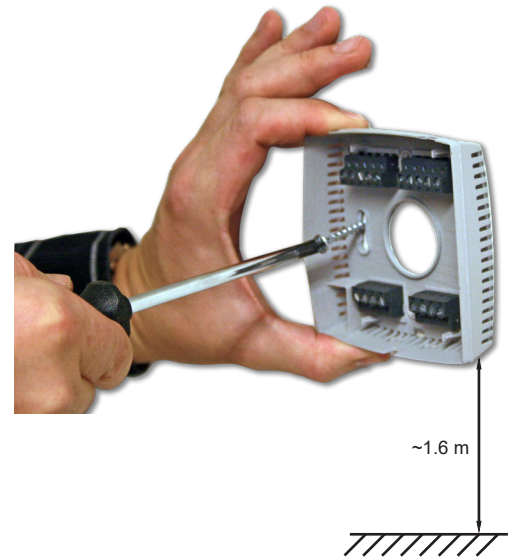

5.

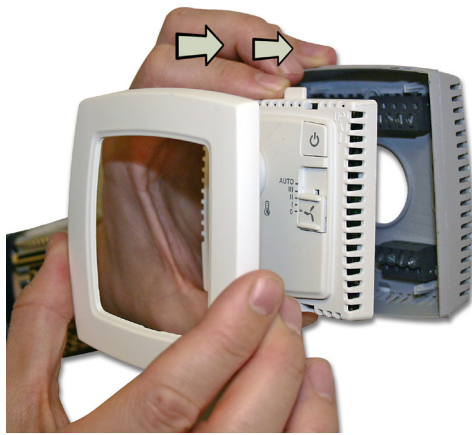

6.

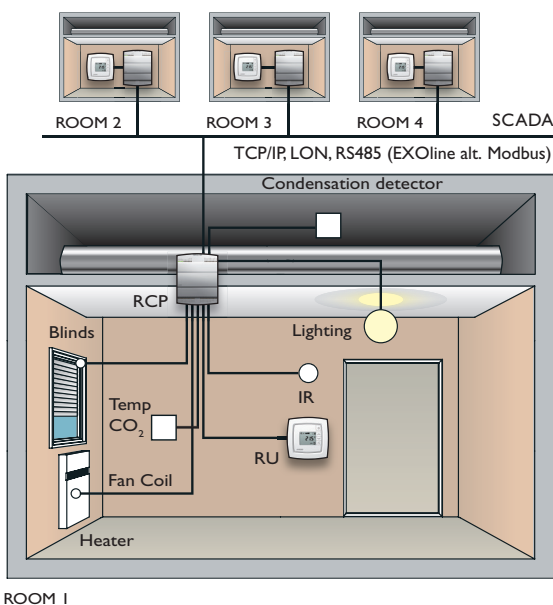
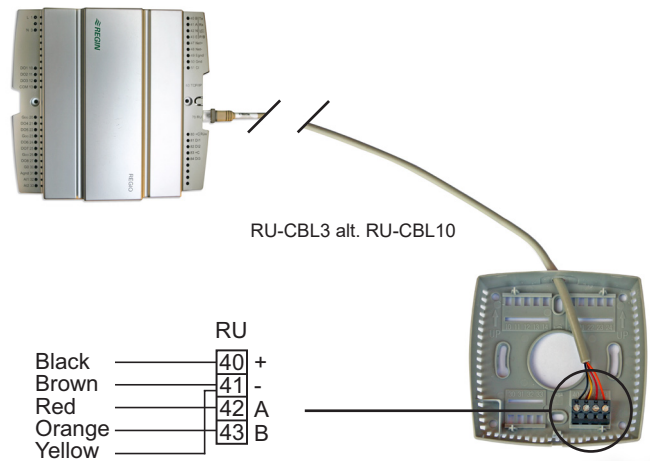

This product carries the CE mark. For more information, see www.regincontrols.com.



Den här produkten är CE-märkt. För mer information, se www.regincontrols.com.



Ce produit est marqué CE. Plus d'informations sont disponibles sur www.regincontrols.com.



Dieses Produkt trägt das CE-Zeichen. Mehr Information können Sie auf www.regincontrols.de finden.